

100 GHz Dense Wavelength Division Multiplexing (DWDM) Optical Add/Drop Module



Key Features

- Accommodates MUX/DEMUX of eight ITU 100 GHz spaced channels onto a fiber pair
- Up to eight channels add/drop capacity at remote sites
- Upgradeable to 32 channels per fiber
- Low-loss pass-through for C-band channels
- Fits into standard LGX mounting solutions
- Thermally stable passive optics; no powering required

Applications

- Capacity exhaust in fiber-constrained applications
- Fiber conservation/reclamation through DWDM
- Multichannel point-to-point
- Linear (bus) add/drop architectures
- Hub-and-spoke ring architectures

The JDSU WaveReady™ 100 GHz Optical Add/Drop Modules (OADM) comprise a family of flexible, low-cost solutions to enable capacity expansion of existing fiber. Through use of DWDM technology, a single optical fiber can carry up to 32 discrete optical channels.

The 100 GHz DWDM OADM is configurable as both an OADM and a terminal multiplexer and demultiplexer (MUX/DEMUX) to support a broad range of architectures ranging from scalable point-to-point links to four-fiber protected rings. Innovative band upgrade ports allow for in-service pay-as-you-grow capacity scaling in multiples of one, four, or eight channels, allowing for lowest first-day cost without limiting growth. Market standard LGX™ packaging is readily deployed in existing LGX-compatible frames or can be adapted into the WaveReady line of shelves.

The 100 GHz OADM is designed to operate with both the WaveReady line of transponder and optical regenerator solutions and ITU transponder cards of widely available transmission equipment.

2

Functional Diagrams

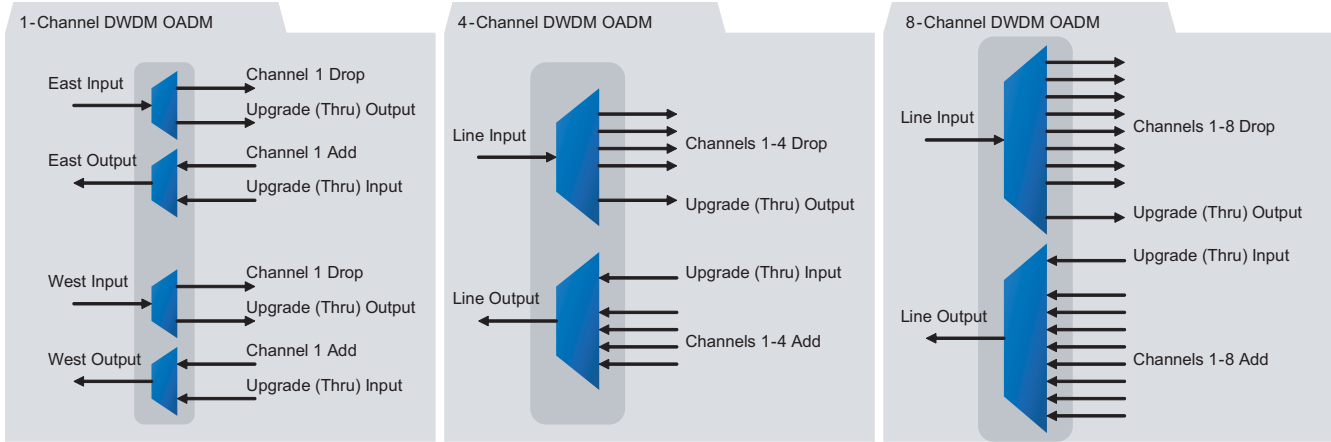

3

Sample Configurations

Point-to-Point DWDM



Protected Linear (Bus) Network

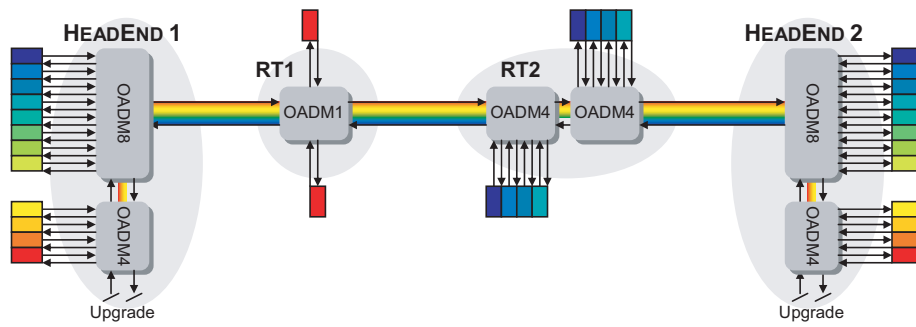

Protected Ring (Hub and Spoke)

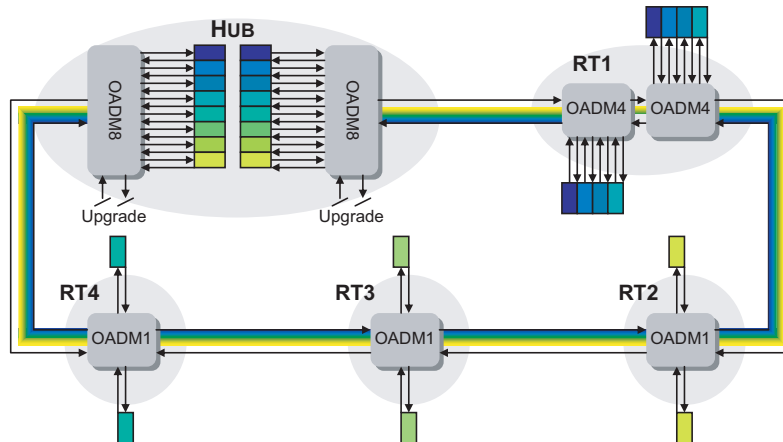

4

Specifications¹

Parameter		1-Channel ²	4-Channel	8-Channel
Network Optical				
Mux/add insertion loss	Maximum	1.4 dB	3.7 dB	4.0 dB
	Typical	1.0 dB	2.6 dB	3.2 dB
Demux/drop insertion loss	Maximum	1.4 dB	3.7 dB	4.0 dB
	Typical	1.0 dB	2.6 dB	3.2 dB
Upgrade path insertion loss	Maximum	0.9 dB	0.9 dB	1.2 dB
Optical pass-through insertion loss	Maximum	1.8 dB	1.8 dB	2.4 dB
Channel passband	Minimum	±0.1 nm	±0.1 nm	±0.1 nm
Channel flatness	Minimum	0.5 dB	0.5 dB	0.5 dB
Channel loss uniformity		-	1 dB	1 dB
Isolation				
Adjacent ITU 100 GHz channel	Minimum	25 dB	25 dB	25 dB
Non-adjacent ITU 100 GHz channel	Minimum	50 dB	50 dB	50 dB
Through channel add/drop	Minimum	30 dB	30 dB	30 dB
Optical return loss	Minimum	40 dB	40 dB	40 dB
Maximum input optical power – sum of all ports		1 W	1 W	1 W
Polarization Dependent Loss (PDL)	Maximum	0.2 dB	0.2 dB	0.2 dB
Polarization Mode Dispersion (PMD)	Maximum	0.2 ps	0.2 ps	0.2 ps
Physical				
Size (H x W x L)		5.10 x 1.12 x 6.31 inch (129.5 x 28.4 x 160.3 mm) single slot LGX	5.10 x 1.12 x 6.31 inch (129.5 x 28.4 x 160.3 mm) single slot LGX	5.10 x 2.27 x 6.31 inch (129.5 x 57.7 x 160.3 mm) double slot LGX
Optical connector type, all ports		Duplex LC/PC	Duplex LC/PC	Duplex LC/PC
Weight, approximate		1.0 lb. (0.45 kg)	1.0 lb. (0.45 kg)	2.0 lb. (0.91 kg)
Environmental				
Operating ambient temperature			-5 to 70 °C	
Storage temperature			-40 to 85 °C	
Relative humidity, non-condensing			5 to 85%	

1. All specifications are guaranteed over the life, operating temperatures, and wavelength range specified.

2. One-channel DWDM OADM provides add/drop functionality for two fiber pairs. Optical specifications for east and west interfaces are identical.

Ordering Information

For more information on this or other products and their availability, please contact your local JDSU account manager or JDSU directly at 1-800-498-JDSU (5378) in North America and +800-5378-JDSU worldwide or via e-mail at customer.service@jdsu.com.

Sample: MDX-04MD1001B
MDX-

Code	Channels
01AD	1
04MD	4
08MD	8

10 **B**

Channel Plan (4- and 8- Channel)		
Code	ITU channels	Wavelength
01	57, 58, 59, 60	1529.55, 1530.33, 1531.12, 1531.90
02	52, 53, 54, 55	1533.47, 1534.25, 1535.04, 1535.82
03	47, 48, 49, 50	1537.40, 1538.19, 1538.98, 1539.77
04	42, 43, 44, 45	1541.35, 1542.14, 1542.94, 1543.73
0A	52, 53, 54, 55, 57, 58, 59, 60	1529.55, 1530.33, 1531.12, 1531.90, 1533.47, 1534.25, 1535.04, 1535.82
0B	42, 43, 44, 45, 47, 48, 49, 50	1537.40, 1538.19, 1538.98, 1539.77, 1541.35, 1542.14, 1542.94, 1543.73
Channel Plan (1-Channel)		
Code	Frequency	Wavelength
60	196.0	1529.55
59	195.9	1530.33
58	195.8	1531.12
57	195.7	1531.90
55	195.5	1533.47
54	195.4	1534.25
53	195.3	1535.04
52	195.2	1535.82
50	195.0	1537.40
49	194.9	1538.19
48	194.8	1538.98
47	194.7	1539.77
45	194.5	1541.35
44	194.4	1542.14
43	194.3	1542.94
42	194.2	1543.73

Note: Please contact your JDSU representative if other ITU wavelengths are required in the range of 1563.86 nm to 1527.99 nm.

Telcordia is a registered trademark of Telcordia Technologies Incorporated.

All statements, technical information and recommendations related to the products herein are based upon information believed to be reliable or accurate. However, the accuracy or completeness thereof is not guaranteed, and no responsibility is assumed for any inaccuracies. The user assumes all risks and liability whatsoever in connection with the use of a product or its application. JDSU reserves the right to change at any time without notice the design, specifications, function, fit or form of its products described herein, including withdrawal at any time of a product offered for sale herein. JDSU makes no representations that the products herein are free from any intellectual property claims of others. Please contact JDSU for more information. JDSU and the JDSU logo are trademarks of JDS Uniphase Corporation. Other trademarks are the property of their respective holders. ©2005 JDS Uniphase Corporation. All rights reserved. 10143156 Rev.001 10/05 OADMWDM.DS.CMS.AE